

Train Driver Simulator



Train driving simulator /1

Train driving simulator, for training onboard train crew and testing its skills and competences. The simulator:

- reproduces the train driving when visibility conditions change (rain, fog, day, night, etc.) with 3D viewing
- calculates speed limits and End of Authority (EOA), displays the supervised speed index, manages critical issues, in real-time, during the journey.
- manages the signalling system and the station itineraries through the Centralized Traffic Control (CTC)
- implements the signalling systems based on SCMT Information Points
- integrates rail line layouts based on planimetry and altimetry, traction and braking curves
- realistically reproduces the driving environment

Train driving simulator /2

SICTR allows to:

- Driver training on real lines operating in normal and unsafe conditions (accidents, breakdowns or other critical events)
- The training of train dispatchers and control room supervisors

It supports:

- Verification and changes of regulations, following technological improvements
- Ground signaling design

Train driving simulator /3

The simulator provides:

- Driving console configured with the Italian SCMT + BACC signaling system
- Line traffic management simulated via Train Describer (CTC function)
- The modularity of the system allows adding other signaling systems (ERTMS, etc.).

Train driving simulator /4



3D interface



Virtual Driving Console



Real Driving Console

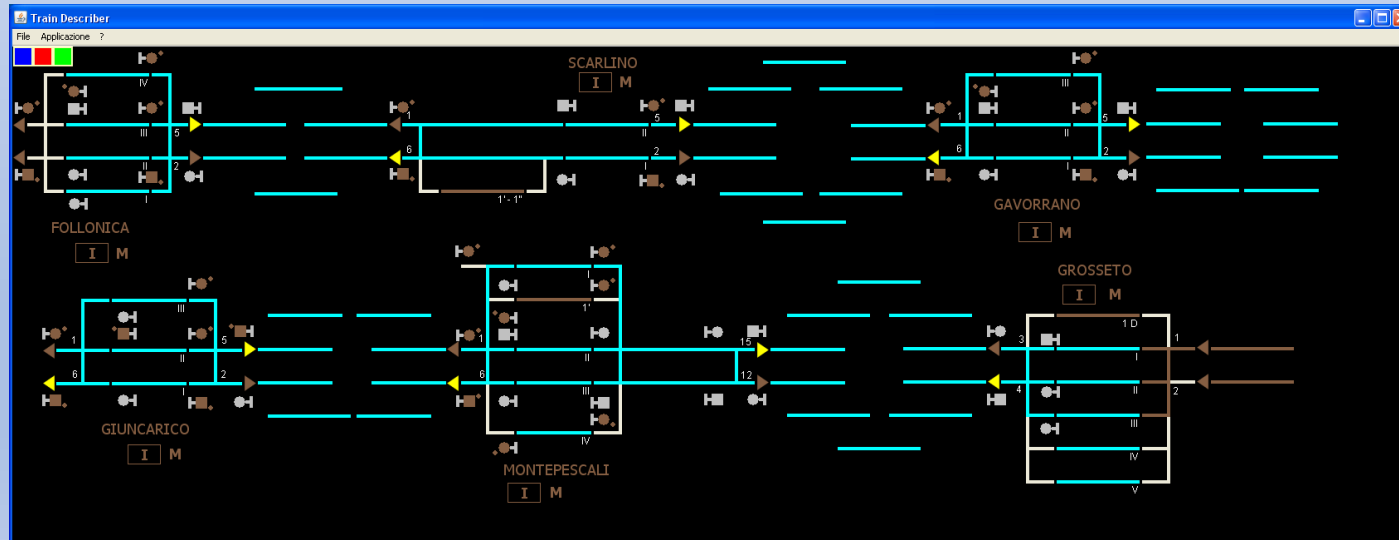

Train describer

Main features

SICTR displays existing preloaded lines.

The rendering engine manages:

- Railway Objects (tracks, signaling systems, bridges, tunnels, level crossings, stations, etc.)
- Landscapes and surrounding areas

HW requirements are:

- Standard PCs for the operator (Driver and CTC / Trainer) and the infrastructure manager interface
- Graphics workstation for the environmental simulation module

Architecture

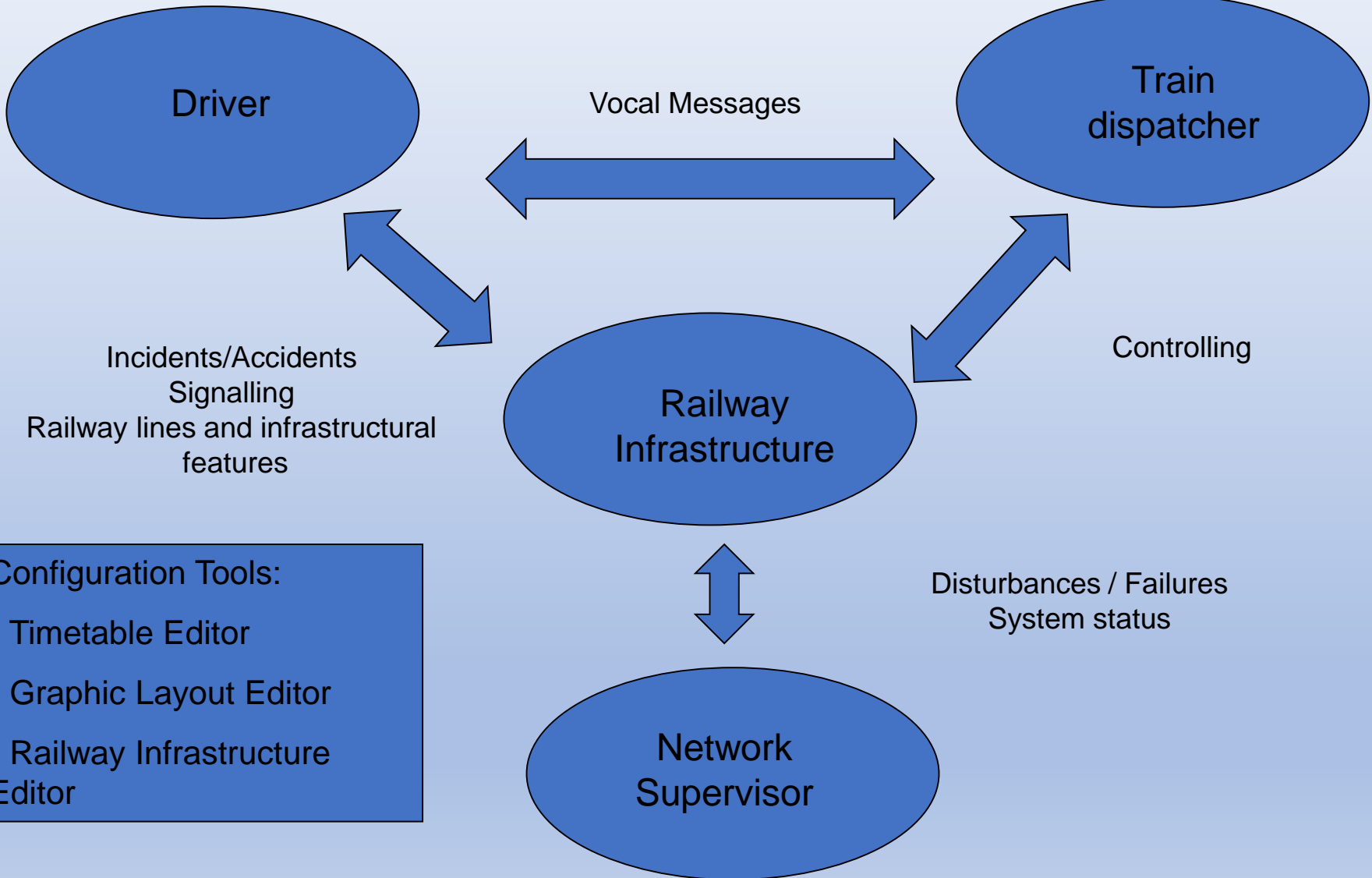

HW Architecture

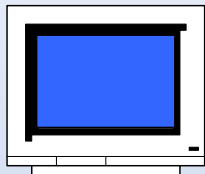

PC Modulo Treno 1
Vista 3D

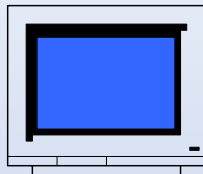

PC Modulo Treno 1
Banco Manovra

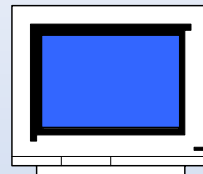

Server Infrastruttura
SimTools
Train Describer
Gestore Infrastruttura

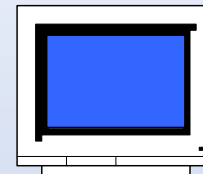

PC Modulo Treno 2
Vista 3D

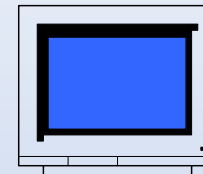

PC Modulo Treno 2
Banco Manovra

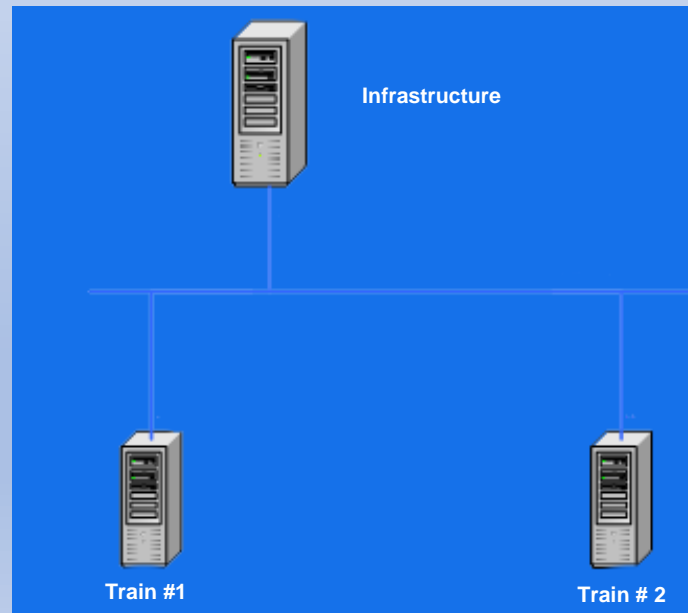
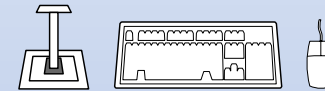
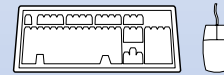
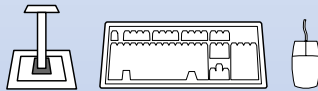

Configuration Tools

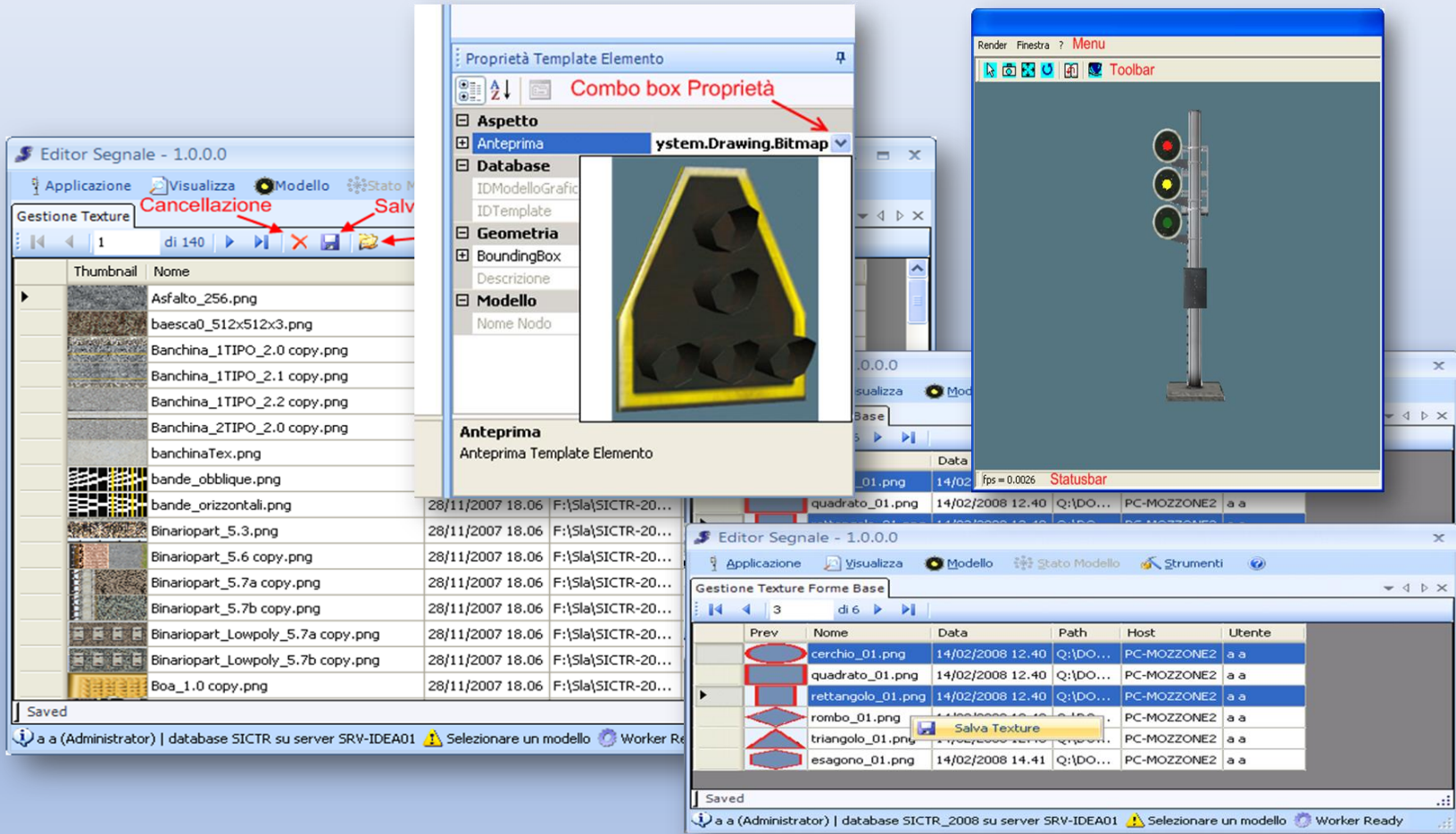

Light signal editor